

HSW 405 T5 INS

CHASIS H1

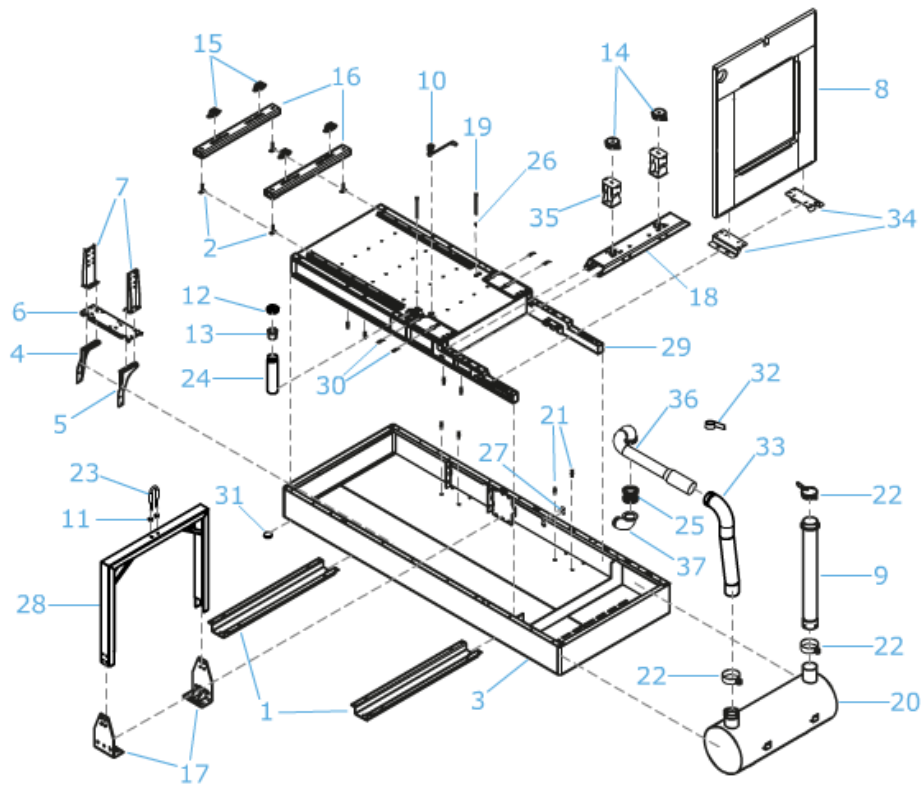

CUBIERTA H1

